



EXP 2905



900 MHz CORDLESS

*with extended range
instruction manual*



Precautions!

Before you read anything else, please observe the following:

Warning!

Uniden America Corporation DOES NOT represent this unit to be waterproof. To reduce the risk of fire, electrical shock, or damage to the unit, DO NOT expose this unit to rain or moisture.

Rechargeable Nickel-Cadmium Battery

Warning

- This equipment contains a rechargeable nickel-cadmium battery.
- Cadmium is a chemical known to the State of California to cause cancer.
- The rechargeable nickel-cadmium battery contained in this equipment may explode if disposed of in a fire.
- **Do not** short-circuit the battery.
- Do not charge the rechargeable nickel-cadmium battery used in this equipment in any charger other than the one designed to charge this battery as specified in the instruction manual. Using another charger may damage the battery or cause the battery to explode.

Rechargeable Nickel-Cadmium Batteries Must Be Recycled or Disposed of Properly



- Uniden voluntarily participates in an RBRC® industry program to collect and recycle nickel-cadmium batteries at the end of their useful life, when taken out of service within the United States. The RBRC® program provides a convenient alternative to placing used nickel-cadmium batteries into the trash or municipal waste stream, which is illegal in some areas.
- Through the RBRC® program, Uniden makes it easy for you to drop off the used battery at local retailers of replacement nickel-cadmium batteries. You may also contact your local recycling center for information on where to return the used battery. Please call 1-800-8-BATTERY for information on Ni-Cd battery recycling in your area. Uniden's involvement in this program is part of its commitment to protecting our environment and conserving natural resources.
- RBRC® is a registered trademark of the Rechargeable Battery Recycling Corporation.

Important Safety Instructions

When using your telephone equipment, these basic safety precautions should always be followed to reduce the risk of fire, electrical shock, and injury to persons:

1. Read and understand all instructions.
2. Follow all warnings and instructions marked on the product.
3. Unplug this product from the wall outlet before cleaning. Use a dry cloth for cleaning without liquid or aerosol cleaners.
4. Do not use this product near water; for example, near a bath tub, wash bowl, kitchen sink or laundry tub, in a wet basement, or near a swimming pool.
5. Do not place this product on an unstable cart, stand, or table. The telephone may fall, causing serious damage to the unit.
6. Slots and openings in the cabinet and the back or bottom are provided for ventilation. To protect the product from overheating, these openings must not be blocked or covered. This product should never be placed near or over a radiator or heat register. This product should not be placed in a built-in installation unless proper ventilation is provided.
7. This product should be operated only from the type of power source indicated on the marking label. If you are not sure of the type of power supply to your home, consult your dealer or local power company.
8. Do not allow anything to rest on the power cord. Do not locate this product where the cord will be damaged by persons walking on it.
9. Do not overload wall outlets and extension cords, as this can result in the risk of fire or electrical shock.
10. Never push objects of any kind into this product through cabinet slots, as they may touch dangerous voltage points or short out parts that could result in a risk of fire or electric shock. Never spill liquid of any kind on the product.
11. To reduce the risk of electric shock, do not disassemble this product. Take it to qualified service personnel when service or repair work is required. Opening or removing covers may expose you to dangerous voltages or other risks. Incorrect reassembly can cause electric shock when the appliance is subsequently used.
12. Unplug this product from the wall outlet and refer servicing to qualified service personnel under the following conditions:
 - A. When the power supply cord is damaged or frayed.
 - B. If liquid has been spilled into the product.
 - C. If the product has been exposed to rain or water.



The exclamation point within an equilateral triangle is intended to alert the user to the presence of important operating and maintenance (servicing) instructions in the literature accompanying the appliance.

- D. If the product does not operate normally when following the operating instructions. (Adjust only those controls that are covered by the operating instructions. Improper adjustment of other controls may result in damage and will often require extensive repair work by a qualified technician.)
 - E. If the product has been dropped or the cabinet has been damaged.
 - F. If the product exhibits a distinct change in performance.
13. Do not use the telephone to report a gas leak in the vicinity of the leak.

Additional Battery Safety Precautions

Caution! To reduce the risk of fire or injury to persons by the battery, read and follow these instructions:

1. Use only the appropriate type and size battery pack specified in the instruction manual.
2. Do not dispose of the battery pack in a fire. The cell may explode. Check the nickel-cadmium battery disposal package insert for disposal instructions.
3. Do not open or mutilate the battery pack. Released electrolyte is corrosive and may cause damage to the eyes or skin. It may be toxic if swallowed.
4. Exercise care in handling the battery in order not to short the battery with conducting materials such as rings, bracelets, and keys. The battery or conductor may overheat and cause burns.
5. Charge the battery pack provided with or identified for use with this product only in accordance with the instructions and limitations specified in the instruction manual provided for this product.
6. Observe proper polarity orientation between the battery pack and battery charger.

SAVE THESE INSTRUCTIONS!

Important Electrical Considerations

Unplug all electrical appliances when you know an electrical storm is approaching. Lightning can pass through your household wiring and damage any device connected to it. This phone is no exception.

Warning!

Please do not attempt to unplug any appliance during an electrical storm.

The FCC Wants You To Know

Changes or modifications to this product not expressly approved by Uniden, or operation of this product in any way other than as detailed by the instruction manual, could void your authority to operate this product. The equipment cannot be used on public coin phone service provided by the telephone company. Connection to party line service is subject to state tariffs. (Contact the state public utility commission, public service commission or corporation commission for information.)

Range

Your new phone is designed to achieve the maximum possible range by transmitting and receiving according to the highest specifications set forth by the FCC. We have rated this phone to operate at a maximum distance with the qualification that the range depends upon the environment in which the telephone is used. Many factors limit range, and it would be impossible to include all the variables in our rating. The Maximum Range rating of this phone is meant to be used as a means of comparison against other range claims.

Telephone Line Problems

The FCC has granted the telephone company the right to disconnect service in the event that your phone causes problems on the telephone line. Also, the telephone company may make changes in facilities and services which may affect the operation of your unit. However, your telephone company must give adequate notice in writing prior to such actions to allow you time for making necessary arrangements to continue uninterrupted service.

If you are having trouble with your telephone service, you must first disconnect your phone to determine if it is the cause of your problem. If you determine that it is the cause, you must leave it disconnected until the trouble has been corrected.

Radio Interference

Radio interference may occasionally cause buzzing and humming in your cordless handset, or clicking noises in the base. This interference is caused by external sources such as TV, refrigerator, vacuum cleaner, fluorescent lighting, or electrical storm. Your unit is NOT DEFECTIVE. If these noises continue and are too distracting, please check around your home to see what appliances may be causing the problem. In addition, we recommend that the base not be plugged into a circuit that also powers a major appliance because of the potential for interference. Be certain that the antenna on the unit is fully extended when needed.

In the unlikely event that you consistently hear other voices or distracting transmissions on your phone, you may be receiving radio signals from another cordless telephone or other source of interference. If you cannot eliminate this type of interference, you need to change to a different channel.

Finally, it should be noted that some cordless telephones operate at frequencies that may cause interference to nearby TVs and VCRs. To minimize or prevent such interference, the base of the cordless telephone should not be placed near or on top of a TV or VCR. If interference is experienced, moving the cordless telephone farther away from the TV or VCR will often reduce or eliminate the interference.

More Than One Cordless Telephone

If you want to use more than one cordless telephone in your home, they must operate on different channels. Press the channel key to select a channel that provides the clearest communication.

Cordless Telephone Privacy

Cordless telephones are radio devices. Communications between the handset and base of your cordless telephone are accomplished by means of radio waves which are broadcast over the open airways. Because of the inherent physical properties of radio waves, your communications can be received by radio receiving devices other than your own cordless telephone unit. Consequently, any communications using your cordless telephone may not be private.

Installation Considerations

Selecting a Location

Before choosing a location for your new phone, there are some important guidelines you should consider:

- The location should be close to both a phone jack and continuous power outlet. (A continuous power outlet is an AC outlet which does not have a switch to interrupt its power.)

- Keep the base and handset away from sources of electrical noise such as motors or fluorescent lighting.
- Be sure there is sufficient space to fully extend the base antenna.
- The base can be placed on a desk or tabletop or mounted on a standard telephone wall plate.
- You should charge your new phone for 15-20 hours before completing the installation or using the handset.

Telephone Line Outlets

There are two types of phone outlets:

Modular Jack

Most phone equipment available now uses modular jacks. Phone cords are fitted with a molded plastic connector which plugs into this type of jack. If you do not have modular phone jacks, contact your local telephone company for information about their installation.

Hardwired Jack

Some equipment is wired directly to a phone jack, and these types of installations require a modular jack converter. This type of installation is not difficult; however, you should contact your Uniden telephone dealer or a telephone supply store for advice about the proper adapter or converter for your particular situation.

Connecting the Telephone Cords

Consider these safety guidelines before connecting the telephone cords:

Caution!

- Never install telephone wiring during a lightning storm.
- Never touch uninsulated telephone wires or terminals unless the telephone line has been disconnected.
- Use caution when installing or modifying telephone lines.

Applying Power to the Base

This phone requires an AC outlet, without a switch to interrupt power, and the included AC adapter. To relieve strain on the DC plug when the phone is placed on a desk or table, wrap the power cord around the strain relief notch on the bottom of the base.

NOTE: Place the power cord so that it does not create a trip hazard, or where it could become chafed and create a fire or other electrical hazards.

Plug the AC Adapter into a standard 120 VAC wall outlet.

Do not use an outlet controlled by a wall switch. Use only the Uniden AC Adapter supplied with this phone.

Table of contents

Getting Started

- 6 Read this first
 - 7 Step 1: Checking the package contents
 - 8 Step 2: Setting up the base phone
 - 11 Step 3: Preparing the battery pack
 - 13 Identifying the parts
-

Basics

- 16 Making calls
 - 18 Redialing
 - 19 Receiving calls
-

Telephone Features

- 20 Memory dialing
 - 20 Storing phone numbers on the handset
 - 21 Storing phone numbers on the base phone
 - 22 Making calls with memory dialing on the handset
 - 22 Making calls with memory dialing on the base phone
- 23 Setting the ringer type
 - 23 Turning off the ringer
 - 24 Checking the ringer type
 - 24 Adjusting the ringer volume level of the base phone

25 Switching the phones during a call

- 25 To switch from the base phone to the handset
- 26 To switch from the handset to the base phone

27 Talking between the handset and the base phone (Intercom)

- 27 To talk from the handset to the base phone
- 28 To talk from the base phone to the handset

29 Transferring a call

- 29 To transfer from the base phone to the handset
- 30 To transfer from the handset to the base phone

31 Having a three-way conference

- 31 To join the phone conversation

Additional Information

- 32 Mounting the base phone on a wall
- 33 Troubleshooting
- 34 Maintenance
- 35 Specifications
- 36 Index
- 39 One Year Limited Warranty

Read this first

Before you use your phone, you must first set it up. Here's a quick way to set up your phone: Steps 1, 2 and 3.

Step 1 (page 7)

First, unpack the phone and the supplied accessories.

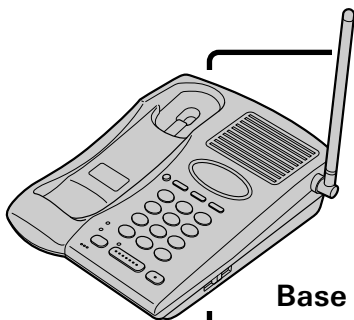

Base phone

Step 2 (pages 8 to 10)

Next, you need to do three things to set up the base phone, including finding the best location for the base phone.

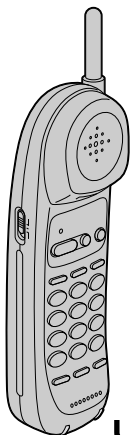

Handset

Step 3 (pages 11 to 12)

Then, insert the battery pack into the handset and charge it for 15-20 hours.

That's it!

About the digital security code

The cordless telephone uses a digital security code to provide protection against unwanted access to your base phone.

The security code blocks other cordless handsets to make calls through your base phone. A random security code will be assigned automatically between your base phone and handset when you charge the battery pack for the first time.

Step 1

Checking the package contents

Make sure you have received the following items in the package.

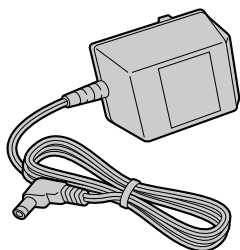

AC power adapter (AD-314)

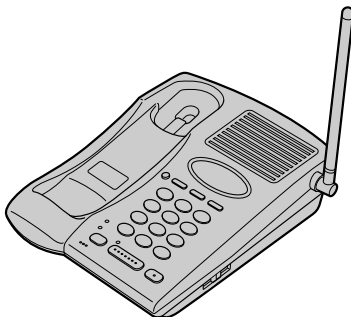

Base phone

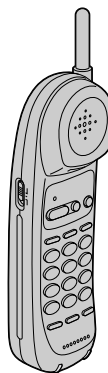

Handset



Telephone line cord (1)

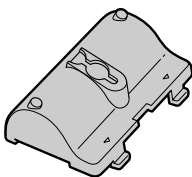

Wall bracket/stand
for base phone

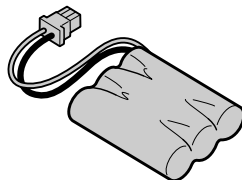

Rechargeable battery
pack (BT-905)

Uniden Parts Department

(800) 554-3988

Hours: M-F 7:00 AM to 5:00 PM CST.

We can also be reached on the web at www.uniden.com

Step 2

Setting up the base phone

Do the following steps:

- Choose the best location
- Connect the base phone
- Choose the dialing mode

Choose the best location

Where you place the base phone affects the reception quality of the handset.

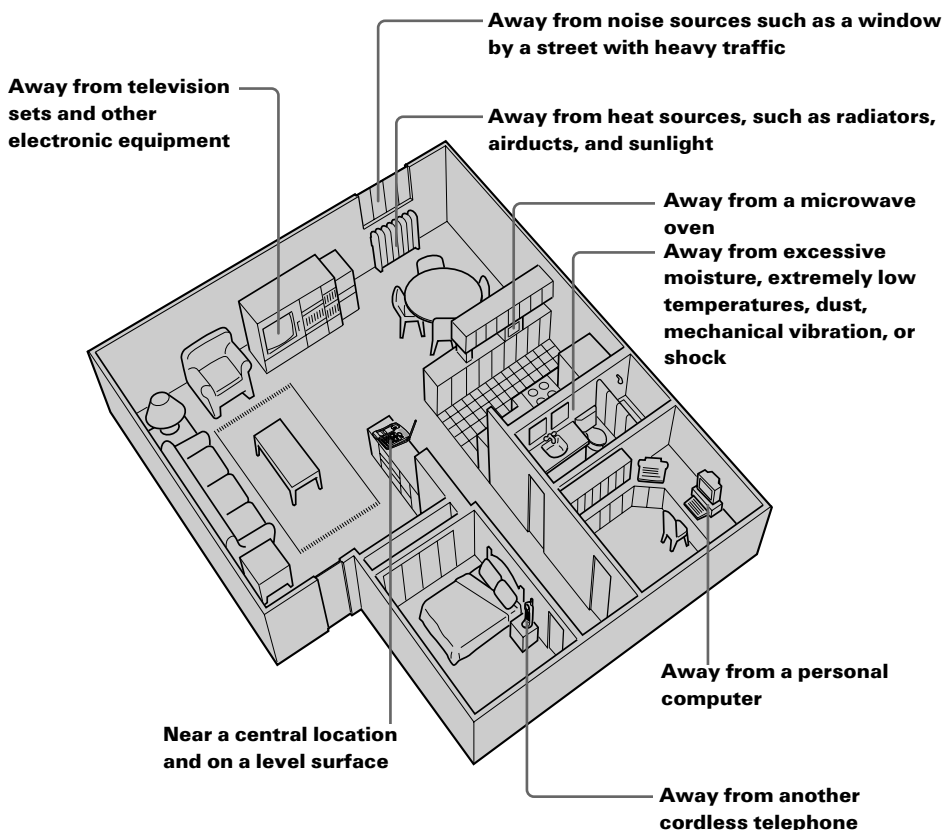

- CAUTION:**
- Should you experience intermittent loss of audio during a conversation, try moving closer to the base or move base phone away from other noise sources.
 - The cordless telephone operates at a frequency that may cause interference to nearby TVs and VCRs; the base phone should not be placed near or on the top of a TV or VCR; and, if interference is experienced, moving the cordless telephone farther away from the TV or VCR will often reduce or eliminate the interference.

Connect the base phone

If you want to hang the base phone on the wall, see page 32.

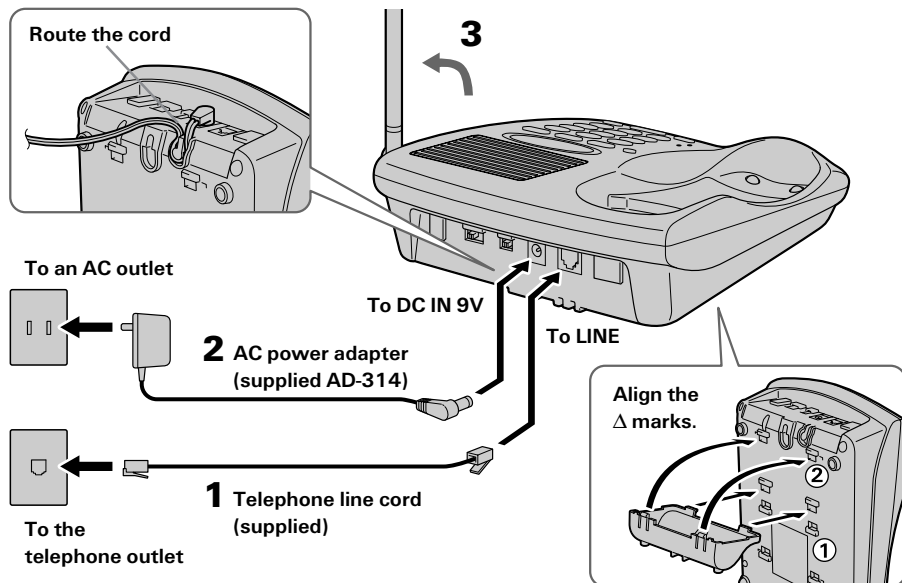

If you want to use the wall bracket as the stand, attach it on the bottom of the base phone before step 1 as illustrated above.

- 1** Connect the telephone line cord to the LINE jack and to a telephone outlet.
- 2** Connect the AC power adapter to the DC IN 9V jack and to an AC outlet.
- 3** Raise the antenna. Make sure it points towards the ceiling.

continued

Step 2: Setting up the base phone (continued)

Notes

- Use only the supplied AD-314 AC power adapter. Do not use any other AC power adapter.
- Connect the AC power adapter to a continuous power supply.
- Place the base phone close to the AC outlet so that you can unplug the AC power adapter easily.

Polarity of the plug



Tip

If your telephone outlet is not modular, contact your telephone service company for assistance.

Modular



Choose the dialing mode

For the telephone to work properly, select an appropriate dialing mode (tone or pulse).

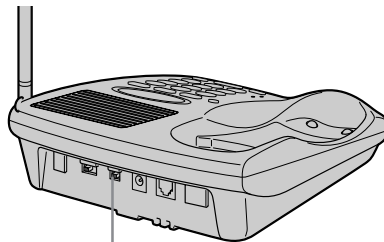

DIAL MODE switch

Depending on your dialing system, set the DIAL MODE switch as follows:

If your dialing system is	Set the switch to
Tone	TONE
Pulse	PULSE

If you aren't sure of your dialing system

Make a trial call with the DIAL MODE switch set to TONE.

If the call connects, leave the switch as is; otherwise, set to PULSE.

Step 3

Preparing the battery pack

Charge the battery pack for 15-20 hours before you start using your phone.

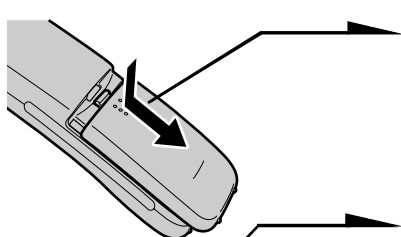

- 1** Slide open the battery compartment lid of the handset.

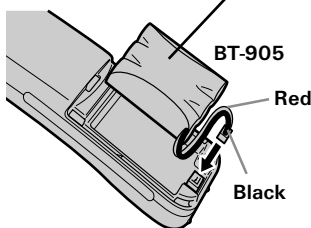

- 2** Connect the battery connector with correct polarity (black wire goes on left side and red wire goes on right).

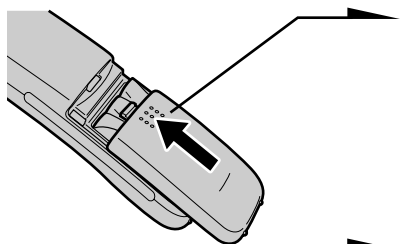

- 3** Close the battery compartment lid.

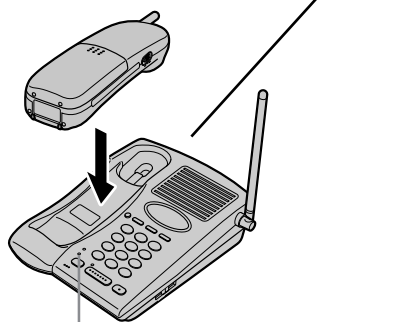

- 4** Place the handset on the base phone. The CHARGE LED lights up when the handset is properly seated on the charge terminals of the base phone. Charge the battery pack for **15-20 hours** so that the battery is fully charged. The CHARGE LED remains lit even after charging is completed.

CHARGE LED

continued

Step 3: Preparing the battery pack (continued)

Battery duration

A fully charged battery pack lasts for about:

- approx. 7 hours when you use the handset continuously.
- approx. 7 days when the handset is in standby mode.

Notes

- The battery pack will gradually discharge over a long period of time, even if not in use.
- If you leave the battery pack in the handset without charging it, the battery pack will be completely discharged.
It may require several times of charging to recover its full capacity.

To obtain the best performance from the battery

Do not place the handset on the base phone after each call. The battery works best if the handset is returned to the base phone after two or three calls. However, do not leave the handset off the base phone for a long period of time as this will completely discharge the battery pack.

When to purchase a new battery pack

If the battery lasts only a few minutes even after **15-20 hours** of charging, the usable life of the battery has expired and needs replacement. Contact Uniden Parts Department (see page 7), and ask for a **BT-905** rechargeable battery pack.

Note

Battery life may vary depending on usage condition and ambient temperature.

Identifying the parts

Refer to the pages indicated in parentheses for details.

Handset

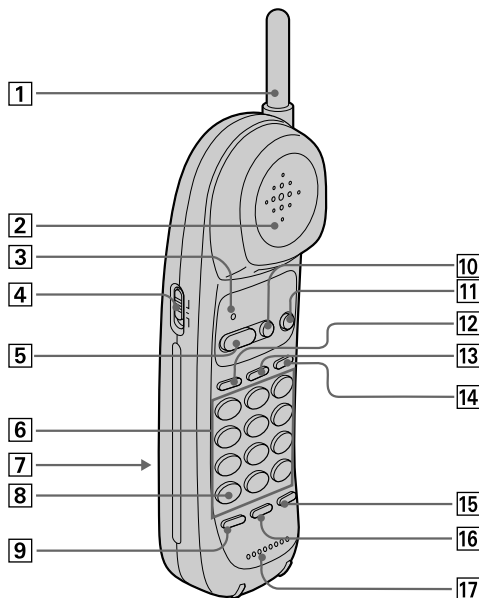

- | | |
|---|--|
| <p>1 Antenna</p> <p>2 Speaker</p> <p>3 TALK/BATT LOW LED
(p. 16, 20)
Lights up during a call, flashes when you store a phone number for memory dialing.</p> <p>4 VOL (volume) switch (p. 16, 19)
Adjusts the handset volume.</p> <p>5 TALK button (p. 16, 19)
Lets you make or receive a call.</p> <p>6 Dialing keys (p. 16)</p> <p>7 Battery compartment (p. 11)</p> <p>8 *TONE button (p. 16, 19)
Allows you to switch temporarily to tone dialing.</p> <p>9 MEMORY button (p. 22)
Used to make a call with memory dialing.</p> | <p>10 OFF button (p. 16, 19)
Allows you to disconnect the call.</p> <p>11 FLASH button (p. 16, 19)</p> <p>12 HOLD button (p. 16, 19, 26)
Used to hold a call.</p> <p>13 INTERCOM button (p. 27)
Used to make an intercom call.</p> <p>14 CHANNEL button (p. 16, 19)
Used to select a better channel.</p> <p>15 REDIAL/P (PAUSE) button
(p. 18, 22)
Redials the last number called, inserts a pause in the dialing sequence.</p> <p>16 SET UP button (p. 20)
Used to store numbers for memory dialing.</p> <p>17 Microphone</p> |
|---|--|

continued

Identifying the parts (continued)

Base Phone

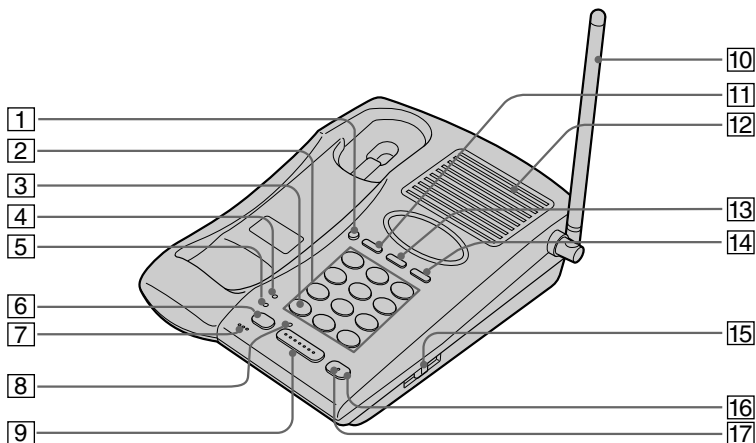

- 1 EDIT button** (p. 21)
Used to store numbers for memory dialing.
- 2 Dialing keys** (p. 17)
- 3 *TONE button** (p. 17, 19)
Allows you to switch temporarily to tone dialing.
- 4 LINE LED** (p. 17, 19, 25)
Lights when one of the phones is in use.
- 5 CHARGE LED** (p. 11)
Lights while the battery is being charged.
- 6 HOLD button** (p. 17, 19, 25)
Used to hold a call.
- 7 MIC (microphone)**
- 8 SPEAKER (PHONE) LED**
(p. 17, 19, 25)
Lights while making or receiving a call with the base phone.
- 9 SPEAKER (PHONE) button**
(p. 17, 19)
Used to make or receive a call with the base phone.
- 10 Antenna** (p. 9, 32)
- 11 REDIAL/P (PAUSE) button**
(p. 18, 22)
Redials the last number called, inserts a pause in the dialing sequence.
- 12 Speaker**
- 13 MEMORY button** (p. 22)
Used to make a call with memory dialing.
- 14 FLASH button** (p. 17, 19)

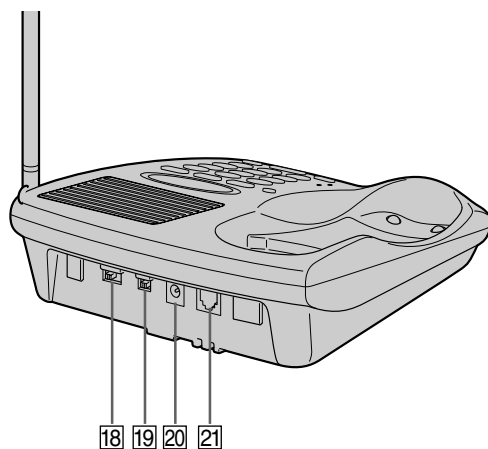

- 15 VOLUME control** (p. 17, 19)
Adjusts the speaker volume.
- 16 INTERCOM button** (p. 28)
Used to make an intercom call.
- 17 INTERCOM LED** (p. 27)
Lights up during an intercom call.
- 18 RINGER switch** (p. 24)
Adjusts the ringer volume.
- 19 DIAL MODE switch** (p. 10)
Selects pulse or tone dialing.
- 20 DC IN 9V jack** (p. 9, 32)
- 21 LINE (telephone line) jack**
(p. 9, 32)

Making calls

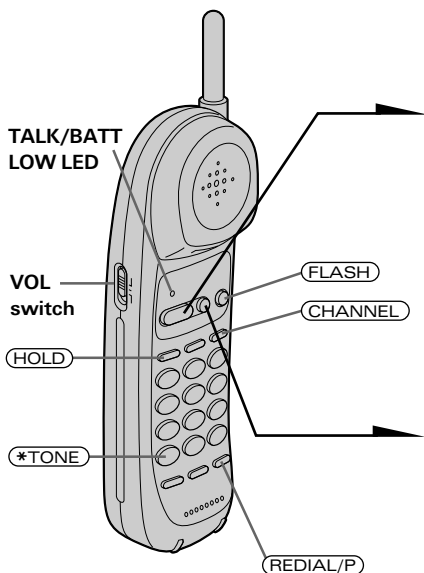

- 1** Pick up the handset from the base phone.
- 2** Press **(TALK)**.
The TALK/BATT LOW LED on the handset and the LINE LED on the base phone light up. Then you'll hear a dial tone. If you hear error beeps, move closer to the base phone.
- 3** Dial the phone number.
- 4** When you're done talking, press **(OFF)** or replace the handset on the base phone.
The TALK/BATT LOW LED on the handset and the LINE LED on the base phone go off.

Additional tasks

To	Do this
Put a call on hold	Press (HOLD) . The TALK/BATT LOW LED flashes slowly. Press (TALK) to resume the conversation.
Select a better channel	Press (CHANNEL) .
Adjust the handset Volume	Set the VOL switch to H (high), M (middle) or L (low).
Switch to tone dialing Temporarily	Press (*TONE) while using the telephone after you're connected. The line remains in tone dialing until disconnected.
Switch to another call ("call waiting" service*)	Press (FLASH) to access the flash function. Press (FLASH) again to return to the first caller.

* You need to subscribe to the service from your telephone company.

Notes

- Before dialing, make sure you can hear the dial tone, otherwise you cannot dial correctly.
- When the TALK/BATT LOW LED repeats a set of two flashes, the base phone is in use.
- When you set the handset volume to H (high), the volume will be raised considerably. Under normal circumstances, set the volume to M (middle).

If the handset battery becomes weak during a call

You hear a beep every three seconds and the TALK/BATT LOW LED on the handset flashes.

The call will disconnect soon. Replace the handset on the base phone to charge.

For optimum performance, charge the battery for 15-20 hours.

Note that during the first 10 - 15 minutes of charging, the phone will be inactive, i.e., unable to make or receive a call.

After this initial 10 - 15 minutes, you **may** be able to use the phone, but the battery duration will be **very short**; thus it is recommended that you **fully charge** the battery before the next usage.

Making calls through the speakerphone

Press **(SPEAKER)** on the base phone.

The SPEAKER LED and the LINE LED light up.

Dial the phone number.

When you are done talking, press

(SPEAKER) again.

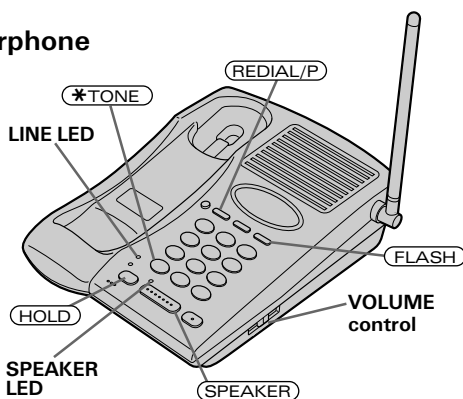

Additional tasks

To	Do this
Put a call on hold	Press (HOLD) . The LINE LED flashes slowly. Press (SPEAKER) to resume the conversation.
Adjust the speaker volume	Press (VOL +) or (VOL -) .
Switch to tone dialing temporarily	Press (*TONE) while using the telephone after you're connected. The line remains in tone dialing until disconnected.
Switch to another call ("call waiting" service*)	Press (FLASH) to access the flash function. Press (FLASH) again to return to the first caller.

* You need to subscribe to the service from your telephone company.

continued

Making calls (continued)

To obtain the best speakerphone performance

- You may not be able to hear the other party's voice in a noisy place. Therefore, use the speakerphone in a quiet room.
- Do not bring your hand or other object too close to the microphone or you will hear a shrill noise ("feedback").
- When the speaker volume is loud, or the telephone has been placed close to a wall, you may find that the volume drops suddenly. This is due to a circuit in the telephone designed to protect against feedback. In such cases, lower the speaker volume slightly.

Redialing

On the handset

- 1** Press **TALK**.
The TALK/BATT LOW LED lights up.
- 2** Press **REDIAL/P** to redial the number last dialed.

On the base phone

- 1** Press **SPEAKER**.
The SPEAKER LED lights up.
“- -” appears on the display.
- 2** Press **REDIAL/P** to redial the number last dialed.

Note

If the number last dialed exceeds 32 digits, only the first 32 digits are dialed.

Tip

The number to be redialed is the last number dialed either on the handset or on the base phone.

Receiving calls

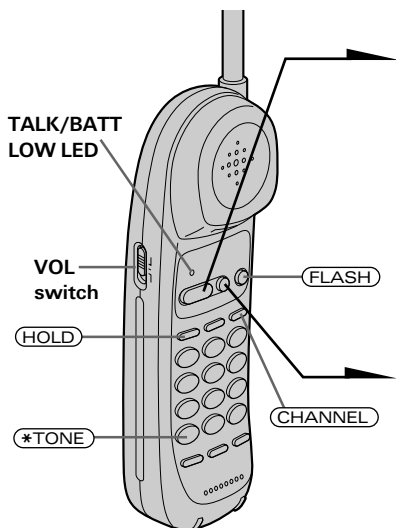

1 When you hear the phone ring;
 • Press **(TALK)**
 (or any key except **(OFF)**).

or

• Pick up the handset from the base phone when the handset is placed on the base phone.

The TALK/BATT LOW LED on the handset and the LINE LED on the base phone light up.

2 When you're done talking, press **(OFF)** or replace the handset on the base phone.

The TALK/BATT LOW LED on the handset and the LINE LED on the base phone go off.

Additional tasks

To	Do this
Put a call on hold	Press (HOLD) . The TALK/BATT LOW LED flashes slowly. Press (TALK) to resume the conversation.
Select a better channel	Press (CHANNEL) .
Adjust the handset volume	Set the VOL switch to H (high), M (middle) or L (low).
Switch to tone dialing temporarily	Press (*TONE) while using the telephone after you're connected. The line remains in tone dialing until disconnected.
Switch to another call ("call waiting" service*)	Press (FLASH) to access the flash function. Press (FLASH) again to return to the first caller.
Turn on/off the ringer of the handset	See "Setting the ringer type" on page 23.

* You need to subscribe to the service from your telephone company.

Receiving calls through the speakerphone

When the phone rings, press **(SPEAKER)** on the base phone.

The SPEAKER LED and the LINE LED light up.

"- -" appears on the display.

To adjust the speaker volume, press **(VOL +)** or **(VOL -)**.

When you are done talking, press **(SPEAKER)** again.

To obtain the best speakerphone performance, see page 18.

To adjust the ringer volume, see page 24.

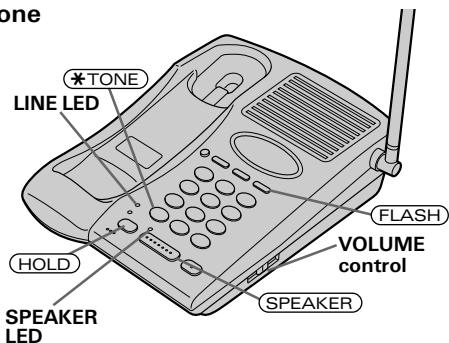

Memory dialing

You can dial with a touch of a few buttons by storing a phone number on a dialing key. You can store up to 10 different phone numbers separately on the handset and on the base phone.

Storing phone numbers on the handset

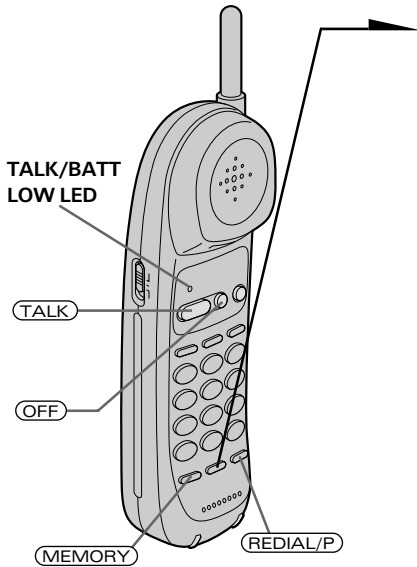

- 1** Press **SET UP**.
The TALK/BATT LOW LED flashes.
- 2** Press one of the dialing keys (0 to 9) for the phone number to be stored.
You'll hear a confirmation beep.
- 3** Enter the phone number you want to store.
You can enter up to 16 digits, including a tone and a pause, each of which is counted as one digit.
- 4** Press **SET UP** again.
You'll hear a confirmation beep, and the number is stored. The TALK/BATT LOW LED goes off.

Notes

- In step 3, if you don't enter the phone number, the previously stored number will be erased.
- Do not allow more than 20 seconds to elapse between each step of the procedure.
- Before storing phone numbers, make sure the handset is not in use.

Tip

If you enter a wrong number, press **OFF**, then start from the beginning.

Storing phone numbers on the base phone

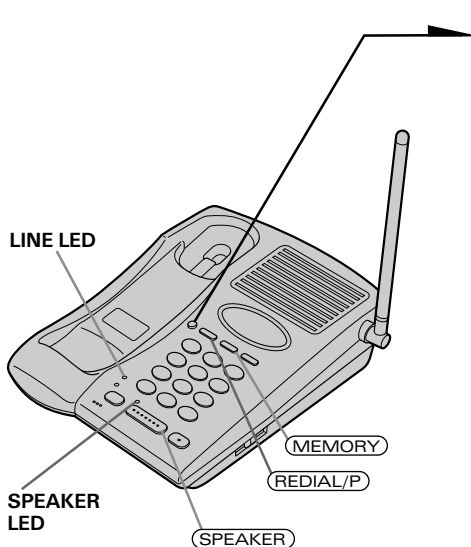

- 1** Press **EDIT** .
The **SPEAKER LED** flashes quickly.
- 2** Press one of the dialing keys (**0** to **9**) for the phone number to be stored.
You'll hear a confirmation beep.
- 3** Enter the phone number you want to store.
You can enter up to 16 digits, including a tone and a pause, each of which is counted as one digit.
- 4** Press **EDIT** again.
You'll hear another confirmation beep, and the number is stored.

Notes

- In step 3, if you don't enter the phone number, the previously stored number will be erased.
- Do not allow more than 20 seconds to elapse between each step of the procedure.
- You cannot store phone numbers on the base phone while the handset is being used. The **LINE LED** will light up to indicate this condition.

Tip

If you enter a wrong number, press **EDIT** , then start from the beginning.

continued

Memory dialing (continued)

To store the previous number dialed

Press **REDIAL/P** directly after step 2, then go to step 4.

To store a number to be dialed via Private Branch Exchange (PBX)

Before entering a phone number in step 3 on the previous page, do as follows:

- 1 Enter the outside line access digit (e.g. 9).
- 2 Press **REDIAL/P** .

To change a stored number

To store a new number, follow the instructions described previously.

To clear a number from memory

- 1 Press **SET UP** on the handset/ **EDIT** on the base phone.
- 2 Press the memory dialing key you want to clear.
- 3 Press **EDIT** again.

Making calls with memory dialing on the handset

- 1 Press **TALK** .
The TALK/BATT LOW LED lights up.
- 2 Press **MEMORY** .
- 3 Enter the desired memory dialing number (**0** to **9**).
The phone number stored in the memory dialing number will be dialed.

Making calls with memory dialing on the base phone

- 1 Press **SPEAKER** .
The SPEAKER LED lights up.
- 2 Press **MEMORY** .
- 3 Enter the desired memory dialing number (**0** to **9**).
The phone number stored in the memory dialing number will be dialed.

Setting the ringer type

You can select a ringer type from four types.

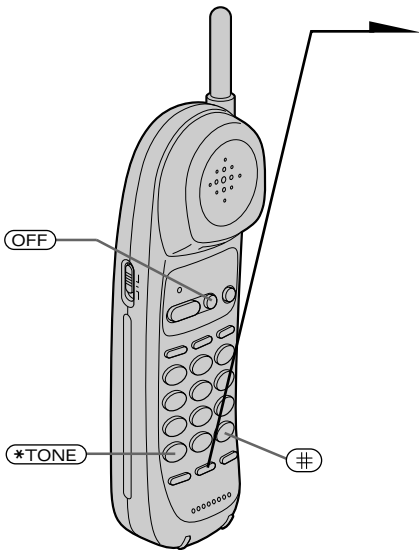

1 Press **SET UP** .

2 Press **#** or ***TONE** .

3 Press a number button, **1** to **4** , to select a ringer type.

You'll hear the corresponding ringer tone.

4 Press **OFF** .

Turning off the ringer

1 Press **SET UP** .

2 Press **#** or ***TONE** .

3 Press **5** .

4 Press **OFF** .

The ringer on the handset is turned off.

To turn the ringer on again

Follow the instructions described in "Setting the ringer type."

Note

Do not allow more than 20 seconds to elapse between each step of the procedure.

continued

Setting the ringer type (continued)

Checking the ringer type

- 1 Press **SETUP**.
- 2 Press **#** or ***TONE**.
- 3 Press **0**.
The currently selected ringer sounds.
- 4 Press **OFF**.

Note

If you hear no sound (only key beep), the ringer on the handset has been turned off.

Adjusting the ringer volume level of the base phone

Set the RINGER switch on the base phone to HIGH or LOW. To turn the ringer off, set it to OFF.

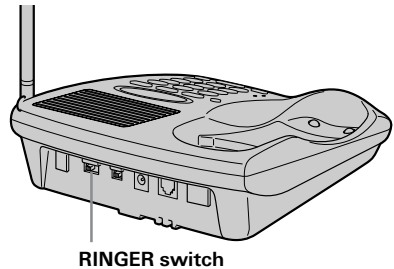

Switching the phones during a call

When you put a call on hold, you can return to the call on the other phone without disconnecting the call.

To switch from the base phone to the handset

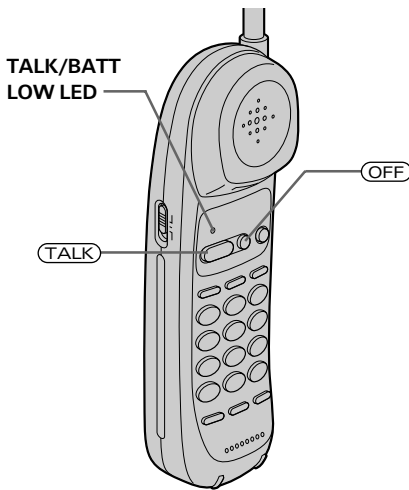
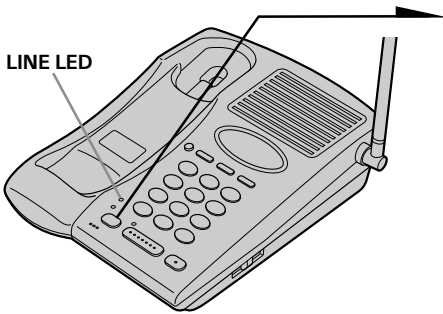

- 1** Press **(HOLD)** on the base phone.
The LINE LED and the TALK/BATT LOW LED on the handset will flash slowly.
- 2** Press **(TALK)** or pick up the handset from the base phone.
The LINE LED and the TALK/BATT LOW LED on the handset will light up.
- 3** When you are done talking, press **(OFF)** or replace the handset to the base phone.

Notes

- If you pick up the handset while talking through the speakerphone on the base phone, the call will be switched to the handset.
- If you do not press **(HOLD)** in step 1, and press **(TALK)** in step 2, you can make a three-way conversation (see “Having a three-way conference” on page 31).
- When the call is put on hold on the base phone, if you pick up the handset, the call will be switched to the handset.

continued

Switching the phones during a call (continued)

To switch from the handset to the base phone

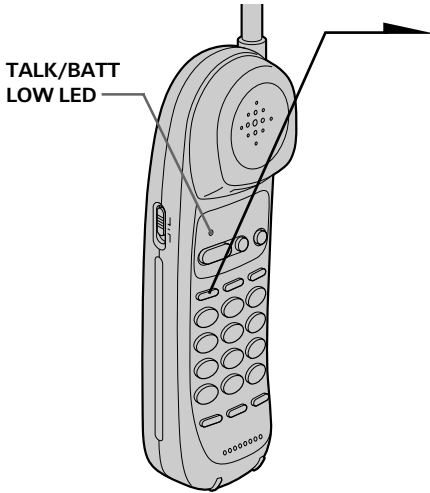

1 Press **(HOLD)** on the handset.
The TALK/BATT LOW LED and the LINE LED on the base phone will flash slowly.

2 Press **(SPEAKER)**.
The SPEAKER LED on the base phone will light up.
The TALK/BATT LOW LED will flash.

3 When you are done talking, press **(SPEAKER)** again.

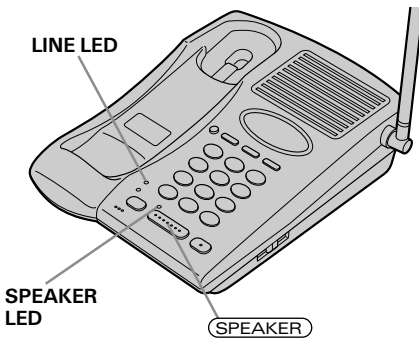

Talking between the handset and the base phone (Intercom)

You can talk between the base phone and the handset. You can start the intercom from either phone.

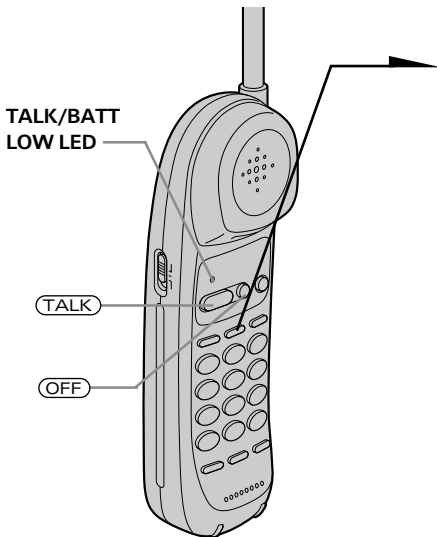

To talk from the handset to the base phone

Press **(INTERCOM)** on the handset. The TALK/BATT LOW LED lights up, and INTERCOM LED on the base flashes.

The base phone rings. You will be connected automatically after 3 seconds.

When a person at the base phone answers, you can talk.

The LINE LED on the base and the TALK/BATT LOW LED on the handset will light up. The INTERCOM LED on the base will light up.

When you are done talking or if no one answers the phone.

Press **(OFF)**.

Tips

- You can receive an intercom call on the base phone even when the RINGER switch on the base phone is set to OFF. The base phone will ring at a low level.
- When a person at the base phone want to answer the intercom call within 3 seconds, press **(INTERCOM)** on the base phone. If a person at the base phone press **(INTERCOM)** after the intercom call is automatically connected, the intercom call will be disconnected.

continued

Talking between the handset and the base phone (Intercom) (continued)

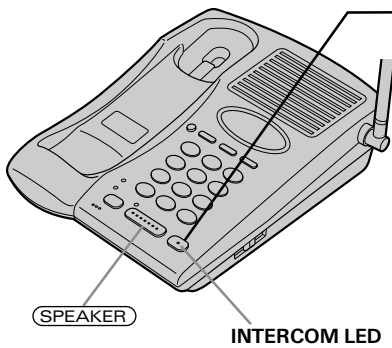

To talk from the base phone to the handset

Press **(INTERCOM)** on the base phone. The handset rings. TALK/BATT LOW LED on the handset flashes.

When the person at the handset presses **(INTERCOM)**, you can talk. The call to the handset will stop by pressing **(OFF)** on the handset.

The LINE LED on the base and the TALK/BATT LOW LED on the handset will light up. The INTERCOM LED on the base phone will light up.

When you are done talking or if no one answers the phone

Press **(INTERCOM)** again.

Notes

- If there is an incoming call while on the intercom, only the base phone rings at a low level. To answer the call, press **(TALK)** on the handset or **(SPEAKER)** on the base phone. The intercom is canceled and you can talk to the outside caller.
- While conversing with an outside caller via the base phone or handset, you cannot make an intercom call. If you press **(INTERCOM)** on the handset, you will hear a busy tone. If you press **(INTERCOM)** on the base phone, it is invalid.

Tip

You can receive an intercom call on the handset even when the ringer is set to off. The handset will ring at a high level.

Transferring a call

You can transfer a call between the handset and base phone without disconnecting the call.

To transfer from the base phone to the handset

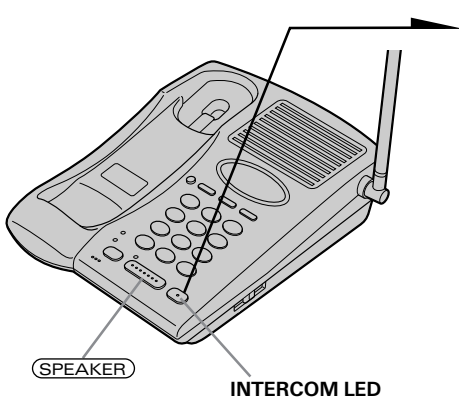

1 Press **INTERCOM** .
The call is put on hold, the handset rings.
The TALK/BATT LOW LED on the handset flashes.

2 Press **INTERCOM** on the handset.
The TALK/BATT LOW LED on the handset and INTERCOM LED on the base phone light up.
You can talk between the base phone and the handset.

3 Press **TALK** on the handset to talk to the caller with the handset.

If no one answers the phone
Press **SPEAKER** on the base phone.

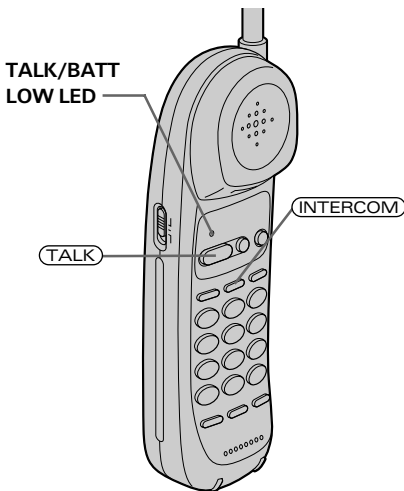

Tip

You can receive an intercom call on the handset even when the ringer is set to off. The handset will ring at a high level.

continued

To transfer from the handset to the base phone

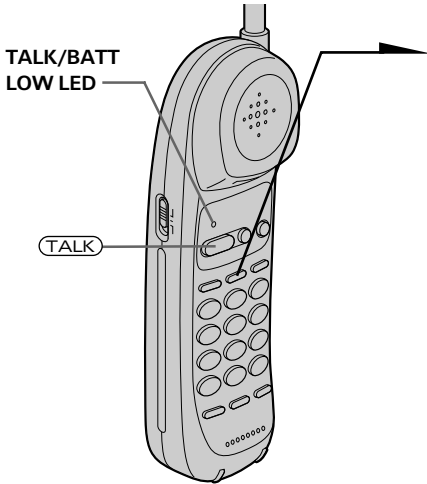

- 1** Press **(INTERCOM)** .
The call is put on hold, the base phone rings.
The INTERCOM LED on the base phone flashes.
You will be connected automatically after 3 seconds.
The TALK/BATT LOW LED on the handset lights up.
When a person at the base phone answers, you can talk.

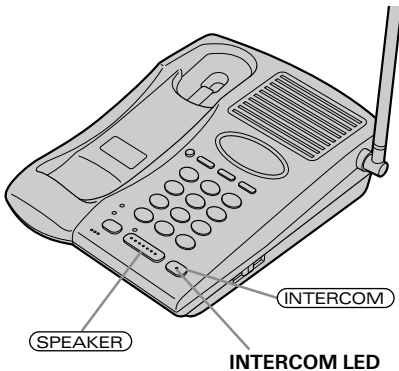

- 2** Press **(SPEAKER)** on the base phone to talk to the caller with the base phone.

If no one answers the phone

Press **(TALK)** on the handset.

Tips

- You can receive an intercom call on the base phone even when the RINGER switch on the base phone is set to OFF. The base phone will ring at a low level.
- When a person at the base phone want to answer the intercom call within 3 seconds, press **(INTERCOM)** on the base phone. If a person at the base phone press **(INTERCOM)** after the intercom call is automatically connected, the intercom call will be disconnected.

Having a three-way conference

The handset and the base phone operate like two extensions on the same line. Both phones can operate at the same time, so that you, the outside caller, and the person at the other phone can engage in a three-way conversation.

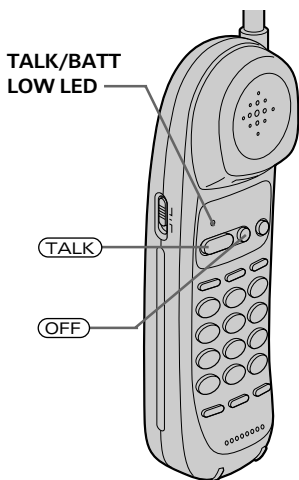

To join the phone conversation

Press **TALK**.

The TALK/BATT LOW LED on the handset lights up.

If you are at the base phone, simply press **SPEAKER**.

The SPEAKER LED on the base phone lights up.

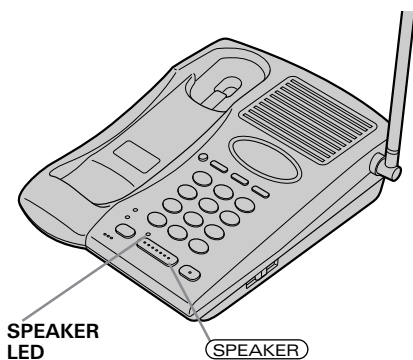

When you are done talking

Press **OFF** on the handset (or press **SPEAKER** if you're at the base phone).

Tip

While talking through the speakerphone on the base phone, if you pick up the handset, the conversation will be continued between the handset and outside caller.

Mounting the base phone on a wall

1

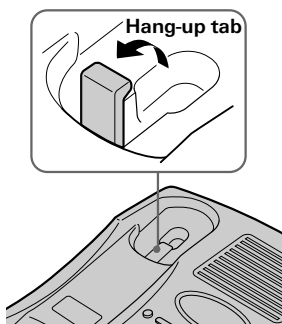

1 Raise the hang-up tab.

2

Plug the telephone line cord to the LINE jack and the AC power adapter to the DC IN 9V jack, and hook the cords.

2

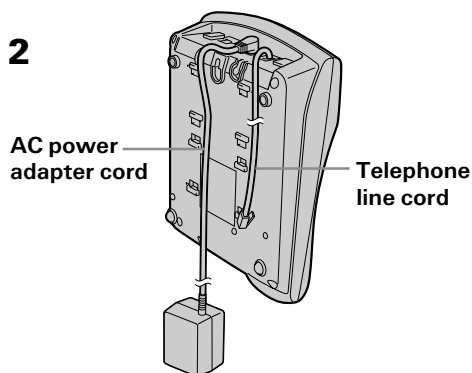

3

Attach the wall bracket to the center of the base phone. Align the Δ marks of the wall bracket with those of the base phone.

3

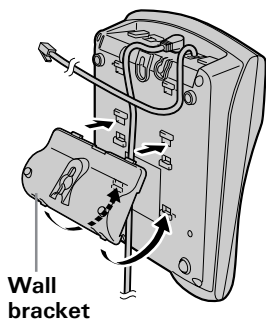

4

Plug the telephone line cord to the telephone outlet, and hook the base phone to the wall plate.

5

Plug the AC power adapter to an AC outlet. Then raise the antenna so that it points towards the ceiling.

4,5

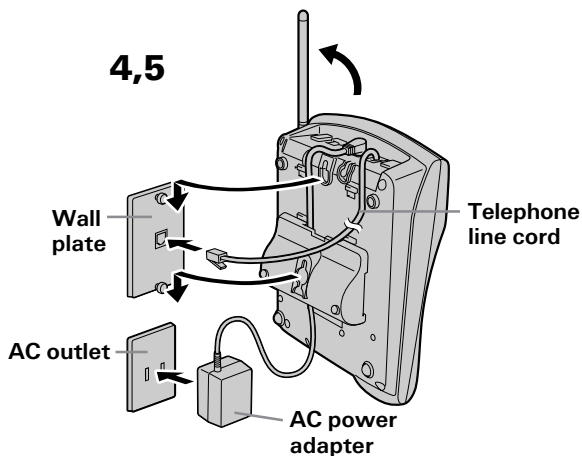

Tip

To remove the wall bracket, press the lower tabs.

Troubleshooting

If you've experienced any of the following difficulties while using your phone, use this troubleshooting guide to help you remedy the problem. Should any problem persist, call our customer hotline at 1-800-297-1023.

	Symptom	Remedy
Making calls	You hear five short error beeps when you press TALK .	<ul style="list-style-type: none"> • Make sure you have set up the base phone correctly (page 8). • Move the handset closer to the base phone. • Replace the handset to the base phone for a while to reset the random security code.
	You hear no dial tone.	<ul style="list-style-type: none"> • Make sure the telephone line cord is securely connected to the telephone outlet. • Make sure the battery is fully charged (page 11).
	The phone does not connect at all, even though the number you have dialed is correct.	<ul style="list-style-type: none"> • Make sure the dialing mode is set correctly (page 10). • Before dialing, make sure you hear a dial tone.
	The phone does not redial correctly.	<ul style="list-style-type: none"> • Make sure the last dialed number is really the one you want to dial.
Receiving calls	The handset does not ring.	<ul style="list-style-type: none"> • Make sure the ringer is turned on (page 23). • The battery may be weak. Charge the battery for 15-20 hours (page 11). • Make sure you have set up the base phone correctly (page 8). • Move the handset closer to the base phone. • Replace the handset to the base phone for a while to reset the random security code.
	The base phone does not ring.	<ul style="list-style-type: none"> • Make sure the telephone line cord is securely connected to the telephone outlet. • Make sure the ringer is turned on (page 24).
During conversation	You hear interference during conversation.	<ul style="list-style-type: none"> • Move the handset closer to the base phone. • Place the base phone away from noise sources (page 8). • Press CHANNEL for a channel that gives better reception.
	You hear a beep every three seconds during the conversation.	<ul style="list-style-type: none"> • The battery is weak. Charge the battery for 15-20 hours.

continued

	Symptom	Remedy
Memory dialing	You cannot store a memory dialing number.	<ul style="list-style-type: none"> • Make sure you follow the procedure in storing the number correctly (page 20). • When the handset is in use, you cannot store a memory dialing number on the base phone. • Replace the handset to the base phone for a while.
	You cannot make a memory dialing call.	<ul style="list-style-type: none"> • You pressed the number button to which no phone number has been stored.
	Memory dialing is incorrect.	<ul style="list-style-type: none"> • Store a correct number (page 20).
Intercom	The handset does not ring when calling from the base phone.	<ul style="list-style-type: none"> • The handset may be engaged in conversation. • The battery may be weak. Charge the battery for 15-20 hours (page 11). • Move the handset closer to the base phone. • Place the base phone away from noise sources (page 8).
Power source/battery	The CHARGE LED does not light up when you place the handset to charge.	<ul style="list-style-type: none"> • Wipe the charge terminals of the base phone and the handset with a soft cloth for better contact of the charge terminals. • Make sure the handset is placed on the base phone properly.
	The battery duration is short.	<ul style="list-style-type: none"> • The battery pack was charged for 15-20 hours (due to power failure, etc.). • The usage life of the battery has expired and needs replacement.

Maintenance

- Clean the cabinets with a soft cloth slightly moistened with water or a mild detergent solution. Do not use any type of abrasive pad, scouring powder or solvent such as alcohol or benzine as they may damage the finish of the cabinet.
- If the charge terminals of the base phone and handset are soiled, wipe them with a soft cloth.

If you have any questions or problems concerning your phone, please call our customer hotline at 1-800-297-1023.

Specifications

General

Frequency band

902 - 928 MHz

Operating channel

40 channels

Dial signal

Tone, 10 PPS (pulse) selectable

Supplied accessories

See page 7.

Handset

Power source

Rechargeable battery pack BT-905

Battery charging time

Approx. 15-20 hours

Battery life

Standby: Approx. 7 days

Talk: Approx. 7 hours

Dimensions

Approx. 54 x 178 x 46 mm (w/h/d),
antenna excluded

(approx. 2 ¹/₄ x 7 ¹/₈ x 1 ¹³/₁₆ inches)

Antenna: Approx. 35 mm

(approx. 1 ⁷/₁₆ inches)

Mass

Approx. 210 g

(approx. 7.4 oz), battery included

Base phone

Power source

DC 9V from AC power adapter

AD-314

Dimensions

Approx. 170 x 65 x 220 mm (w/h/d),
antenna excluded

(approx. 6 ³/₄ x 2 ⁵/₈ x 8 ³/₄ inches)

Antenna: Approx. 150 mm

(approx. 6 inches)

Mass

Approx. 560 g

(approx. 1 lb 4 oz), wall bracket excluded

Design and specifications are subject to
change without notice.

continued

Index

A

Adjusting volume
handset volume 16
speaker volume 17, 19

B

Battery pack
charging 11
duration 12

C

Connection 9

D, E, F, G, H

Dialing mode
choosing 10
switching to the tone
temporarily 16, 17, 19

I, J, K

Identifying the parts 13
Intercom 27

L

Location, base phone 8

M, N, O

Making calls 16
Memory dialing 20
Mounting the base phone
on a wall 32

P, Q

Package contents 7
Pulse dialing 10

R

Receiving calls 19
Redialing 18
Ringer
adjusting the base ringer
24
setting the ringer
type 23
turning on/off 23

S

Setting up
base phone 8
handset 11
Speaker 17, 19
Switching the phones
during a call 25

T, U

Talking between the
phones 27
Three-way conference 31
Tone dialing
dialing mode 10
switching to 16, 19
Transferring a call 29
Troubleshooting 33

V, W, X, Y, Z

Volume
handset 16
speaker 17, 19

Note

Note

One Year Limited Warranty

Important: Evidence of original purchase is required for warranty service.

WARRANTOR: UNIDEN AMERICA CORPORATION (“Uniden”)

ELEMENTS OF WARRANTY: Uniden warrants, for one year, to the original retail owner, this Uniden Product to be free from defects in materials and craftsmanship with only the limitations or exclusions set out below.

WARRANTY DURATION: This warranty to the original user shall terminate and be of no further effect 12 months after the date of original retail sale. The warranty is invalid if the Product is (A) damaged or not maintained as reasonable or necessary, (B) modified, altered, or used as part of any conversion kits, subassemblies, or any configurations not sold by Uniden, (C) improperly installed, (D) serviced or repaired by someone other than an authorized Uniden service center for a defect or malfunction covered by this warranty, (E) used in any conjunction with equipment or parts or as part of any system not manufactured by Uniden, or (F) installed or programmed by anyone other than as detailed by the Instruction Manual for this product.

STATEMENT OF REMEDY: In the event that the product does not conform to this warranty at any time while this warranty is in effect, warrantor will either, at its option, repair or replace the defective unit and return it to you without charge for parts, service, or any other cost (except shipping and handling) incurred by warrantor or its representatives in connection with the performance of this warranty. Warrantor, at its option, may replace the unit with a new or refurbished unit. **THE LIMITED WARRANTY SET FORTH ABOVE IS THE SOLE AND ENTIRE WARRANTY PERTAINING TO THE PRODUCT AND IS IN LIEU OF AND EXCLUDES ALL OTHER WARRANTIES OF ANY NATURE WHATSOEVER, WHETHER EXPRESS, IMPLIED OR ARISING BY OPERATION OF LAW, INCLUDING, BUT NOT LIMITED TO ANY IMPLIED WARRANTIES OF MERCHANTABILITY OR FITNESS FOR A PARTICULAR PURPOSE. THIS WARRANTY DOES NOT COVER OR PROVIDE FOR THE REIMBURSEMENT OR PAYMENT OF INCIDENTAL OR CONSEQUENTIAL DAMAGES.** Some states do not allow this exclusion or limitation of incidental or consequential damages so the above limitation or exclusion may not apply to you.

LEGAL REMEDIES: This warranty gives you specific legal rights, and you may also have other rights which vary from state to state. This warranty is void outside the United States of America.

PROCEDURE FOR OBTAINING PERFORMANCE OF WARRANTY: If, after following the instructions in the Instruction Manual you are certain that the Product is defective, pack the Product carefully (preferably in its original packaging). The Product should include all parts and accessories originally packaged with the Product. Include evidence of original purchase and a note describing the defect that has caused you to return it. The Product should be shipped freight prepaid, by traceable means, to warrantor at:

Uniden America Corporation

Parts and Service Division

4700 Amon Carter Blvd.

Fort Worth, TX 76155

(800) 297-1023, 7 a.m. to 7 p.m. Central, Monday through Friday

A World Without Wires | Uniden®

Covered under one or more of the following U.S. patents:

4,511,761	4,523,058	4,595,795	4,797,916	5,381,460	5,426,690
5,434,905	5,491,745	5,533,010	5,574,727	5,650,790	5,660,269
5,661,780	5,663,981	5,671,248	5,717,312	5,754,407	5,768,345
5,787,356	5,838,721	5,864,619	5,893,034	5,912,968	5,915,227
5,929,598	5,930,720	5,960,358	5,987,330	6,044,281	6,070,082
6,125,277					

© 2001 Uniden America Corporation, Fort Worth, TX
All rights reserved. Printed in China.

UCZZ01362ZZ